

Article number: 0120052

Description: Retaining ring AL 35X1,5  
Spring steel

## Measures

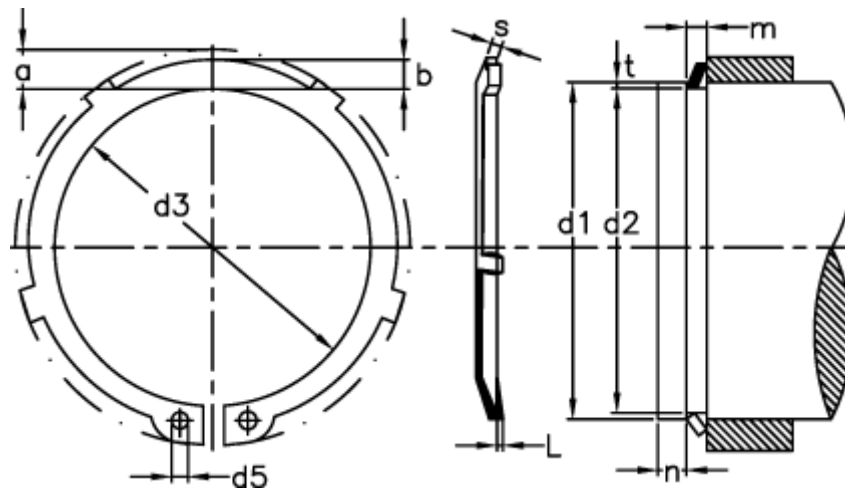

a max	= 5.2	FL max kN	= 0.93	s	= 1.50
b	= 3.8	FN kN	= 17.80	tol	= -0.25
C kN/mm	= 2.32	FRg kN	= 5.50	tol	= +0,25 -0,50
d1	= 35	FR kN	= 30.8	u	= 0.10
d2	= 33.0	g	= 2.0		
d3	= 32.2	L min	= 0.50		
d5 min	= 2.5	m min	= 1.60		
Description	= AL 35	Nominal drive	= 3.0		